

PlateRite 8000N Series

Thermal Plate Recorders



Creating a Future in Print

The PlateRite 8000N series: Advanced CtP units that make high-performance CtP output a reality in your production environment

The high-performance B1-format PlateRite 8000N series of thermal plate recorders feature Screen's unique external drum imaging technology combined with high-precision optics. These units boast cutting-edge functions that take full advantage of the high quality offered by thermal plates. They can also be paired with a variety of automated systems that enable long periods of unmanned operation, facilitating timely plate delivery and contributing significantly to higher press operating ratios.



A full lineup of PlateRite 8000N series models, to suit any need

The PlateRite 8800N-ZX/Z/S/E

The PlateRite 8800N-ZX features a 1,024-channel imaging head with the latest GLV™ technology. This new imaging head makes it possible for the PlateRite 8800N-ZX to output a remarkable 51 B1-size plates per hour, the highest productivity in its class. It also provides the high-quality halftone dot reproduction users have come to expect in thermal plate output, for the perfect marriage of quality and productivity.

The PlateRite 8800N-E/S/Z models feature a 512-channel imaging head.

The PlateRite 8600N-Z/S/E

The PlateRite 8600N-Z/S/E are standard thermal CtP recorders that output B1-size plates. The PlateRite 8600N-Z and PlateRite 8600N-S feature a 64-channel light source that makes it possible to output a blistering 23 B1-size plates per hour on the high-speed rotating drum. The PlateRite 8600N-E features a 32-channel light source; the PlateRite 8600N-E can output up to 14 B1-size plates per hour.

The PlateRite 8300N-S/E

The PlateRite 8300N-E/S are entry-level thermal CtP recorders that output B1-size plates. The PlateRite 8300N-S combines a 32-channel light source and a high-speed drum to enable output at a respectable 14 B1-size plates per hour. The more economical PlateRite 8300N-E utilizes a 16-channel light source and can output up to 8 plates per hour.

High resolution (option)

The PlateRite 8800N-Z/S/E and PlateRite 8600N-Z offers high-resolution 4,000 dpi support. This is perfect for everything from high-resolution art printing to the accurate reproduction of small text sizes like those required for bond and other certificate printing. This function is available for the PlateRite 8800N-Z/S/E and the PlateRite 8600N-Z to output high-quality 4,000 dpi 3D lenticular printing plates.*

* 4,000 dpi support comes as option for the 8800N-Z/S/E.

Productivity (1,030 x 800 mm (40.5" x 31.4") plates, at 2,400 dpi)

	Light source (Laser diodes)	Productivity
PlateRite 8800N-ZX	1,024ch	51 Plate/hr
PlateRite 8800N-Z	512ch	42 Plate/hr
PlateRite 8800N-S	512ch	36 Plate/hr
PlateRite 8800N-E	512ch	26 Plate/hr
PlateRite 8600N-Z	64ch	23 Plate/hr
PlateRite 8600N-S	64ch	23 Plate/hr
PlateRite 8600N-E	32ch	14 Plate/hr
PlateRite 8300N-S	32ch	14 Plate/hr
PlateRite 8300N-E	16ch	8 Plate/hr

A full range of advanced features that support high quality and high productivity

Regular monitoring of production status from a remote location

Remote monitoring allows users to keep an eye on CtP operating conditions and output history from a remote location, using a web browser or e-mail. E-mails can also be sent automatically to the service center and entered into a database for use in maintenance, repairs, and periodic inspections, ensuring that the CtP recorder is in optimal operating condition at all times.

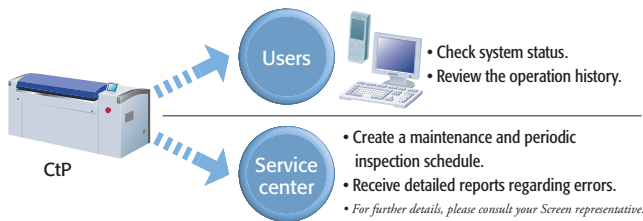

Stable drum rotation

The PlateRite 8000N series features a unique auto-balancing feature. The operator simply selects the appropriate pre-registered plate size and type during setup, and the recorder automatically makes the necessary adjustments to ensure perfect drum balance. This results in stable, high-speed drum rotation for all the plate sizes and thicknesses handled by the recorder.

Maximized available image area

The minimum clamp size that can be used with the PlateRite 8000 N series is 8 mm, for both the leading and trailing edge clamps (with a leading edge clamp size of just 6 mm in the 8800N series). The available imaging area is extremely large, so plates can be used for a wide range of printing press types. This helps reduce the amount of effort involved in plate handling and increases printing press operating ratios, thereby contributing significantly to increased productivity.

* When the notchless PlateRite 8800N (option) is selected, the clamp size is even smaller.

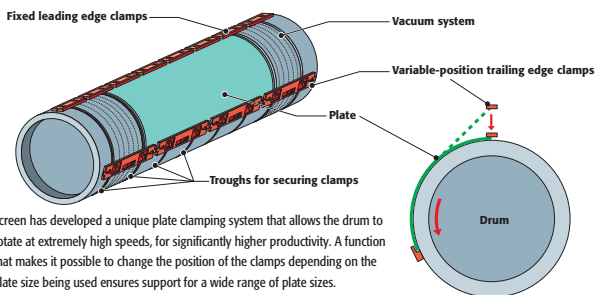

Superior registration accuracy

The PlateRite 8000N series features an automatic inline punching system that helps enable perfect registration on press. Plates are punched by this automatic inline punching system immediately before being loaded onto the drum. The registration punch holes ensure consistent plate placement on the drum, when used in conjunction with standard registration pins. This helps eliminate imaging variations caused by improper plate placement, and ensures superior registration accuracy.

When optional printing press punch blocks*¹ are used, the imaged plates can be loaded directly onto the press after output. The use of printing press punch blocks during plate output eliminates the need for manual punching later on in the workflow, ensures excellent registration accuracy, and creates the foundation for perfect results on press. It also dramatically shortens press make-ready time and improves press operating ratios, for even better overall productivity.

*¹ Up to eight individual punch blocks can be selected and mounted, depending on the plate sizes and printing press types being used.

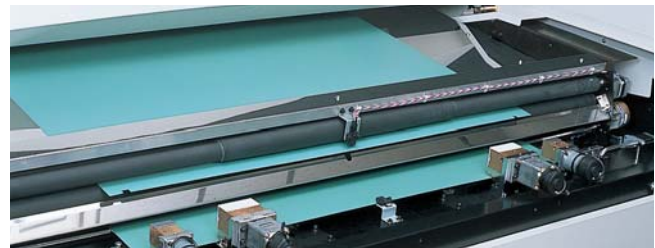

Upgrade to create the optimal CtP environment

The PlateRite 8800N/8600N/8300N units all have certain parts that can be replaced to upgrade them to higher model types (upgrade is a paid option). These flexible recorders can be upgraded as productivity needs change to create an optimal production environment.

Check operation status at a glance

The PlateRite 8000N series models come standard with a signal light at the top of the unit that makes it easy to check CtP operation status and see if there have been any errors. An optional signal tower that improves visibility regardless of the operator's position is also available.

Signal light

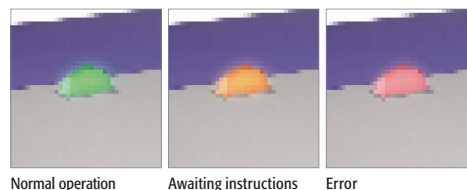

Signal tower



Improved productivity with automation of everything from plate loading to delivery

The PlateRite 8000N series units can be used with auto-loaders that automate plate loading, imaging, transport, developing, and delivery. These auto-loaders enable long periods of continuous production and contribute significantly to improved productivity and better printing press operating ratios.



MA-L8800N-ZX

Processor bridge completes automated line, and is compatible with major processor types

Automatic punching by the printing press punch

Innovative plate handling system prevents damage to the front of the plate during transport

Sensor automatically detects plate/interleaf paper

Automatic delivery of interleaf paper to interleaf paper collection box

Up to 5 cassettes, each with up to 100 plates
Up to 5 different plate sizes (or all same)
Maximum of 500 plates loaded without operator intervention

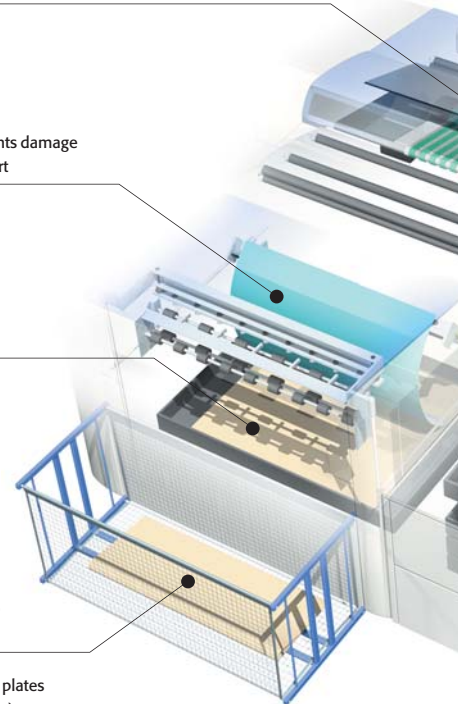

Customize your system by choosing anything from semi-automatic to fully automatic plate

SA-L8800N-ZX/8800N single-cassette autoloader (option)

The SA-L 8800N-ZX/8800N single-cassette autoloader can hold up to 100 plates, which makes long periods of continuous unmanned operation possible. It automatically removes interleaf paper and sends it to an external collection box just before each plate is loaded. No contact is made with the sensitive emulsion side of the plate at any stage during transport, eliminating the risk of damage to the plate. Manual loading is also possible, providing the flexibility to use different sized plates whenever required.

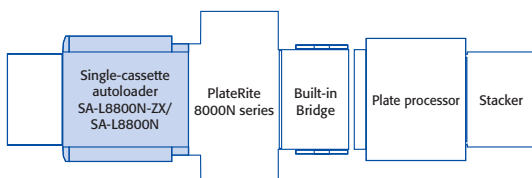

	PlateRite 8800N-ZX	PlateRite 8800N-Z/S/E, PlateRite 8600N, PlateRite 8300N
Single-Cassette autoloader	SA-L8800N-ZX	SA-L8800N
Multi-Cassette autoloader	MA-L8800N-ZX	MA-L8800N
Processor bridge		Built-in Bridge, AT-T8001R, AT-M8001

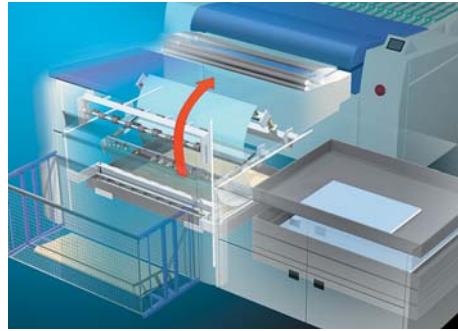
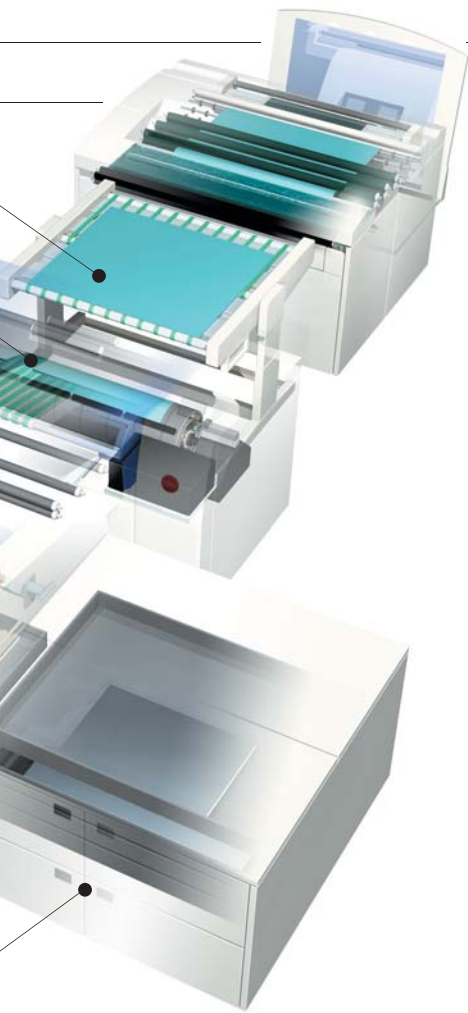

1 The arm goes to pick up the plate, and the plate is hoisted up to the engine section.

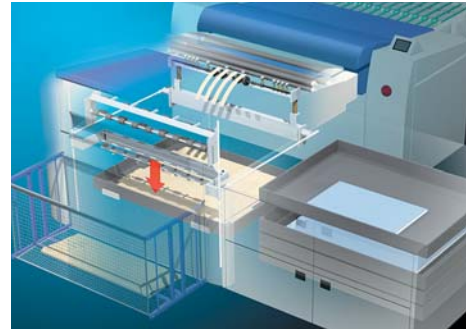

2 The interleaf paper adheres to the suction pads and is removed.

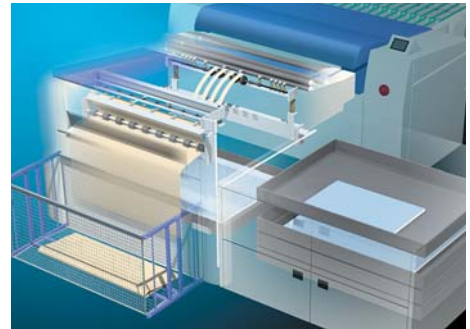

3 The interleaf paper is lifted away and ejected into an external collection box.

handing

MA-L8800N-ZX/8800N multi-cassette autoloader (option)

The MA-L8800ZX/8800N multi-cassette autoloader enables complete automation of the cassette changing and plate loading processes. It is attached as an extension to the single-cassette autoloader. It comes standard with three cassettes, with each cassette holding up to 100 plates. An additional two cassettes are available as an option. The use of five cassettes enables automatic switching between up to 500 plates of five different sizes, as necessary for the job at hand. When the same size of plate is loaded in each cassette, extremely long periods of unmanned operation are possible.

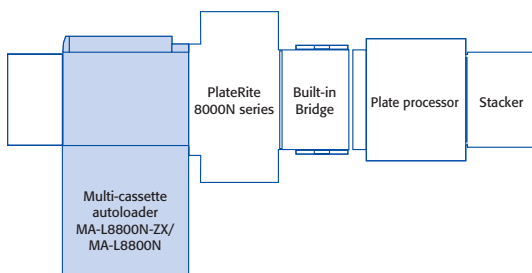

Multi-bridge AT-M8001

The AT-M8001 is a multi-bridge that can connect the PlateRite 8000N series to multiple plate processors. It allows you to connect the PlateRite 8000N series to two different plate processors and then switch the transport line between them as necessary to process different types of plates at different plate processors. It's also possible to set the transport line up in an L-shape. The flexibility to select the L-shape layout is particularly useful when a straight-line layout is not possible due to space constraints, or if a small automatic plate processor is used.

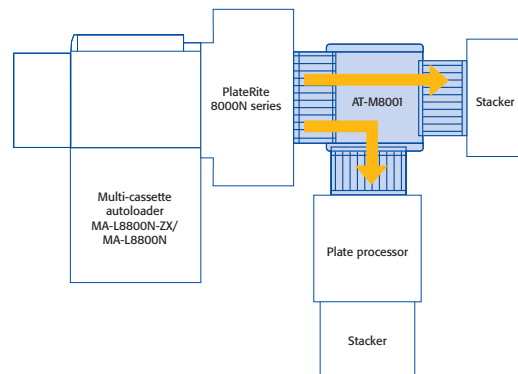

PlateRite 800N series specifications/diagram

PlateRite 8800N-ZX/Z/S/E specifications

	PlateRite 8800N-ZX	PlateRite 8800N-Z	PlateRite 8800N-S	PlateRite 8800N-E
Recording system	External drum			
Light source	1,024-channel laser diode	512-channel laser diode		
Plate size	Maximum: 1,160 x 940 mm (45.6" x 37"); Minimum: 304 x 370 mm (12.0" x 14.6")			
Exposure size	Maximum: 1,160 x 929 mm (45.6" x 36.5") [(when the notchless option is selected)* ¹]			
Media	Thermal plates			
Media thickness* ²	0.15 to 0.3 mm (5.9 mil to 11.8 mil) [0.4 mm (15.7 mil) available as an option]			
Resolutions (dpi)	1,200* ³ /2,400/2,438/2,540/4,000 (4,000 dpi is only available for the PlateRite 8800N-Z/S/E when the high-resolution option is selected)			
Repeatability	± 5 microns* ⁴			
Productivity* ⁵	51 plates/hr at 2,400 dpi (1,030 x 800 mm/40.5" x 31.4" plates)	42 plates/hr at 2,400 dpi (1,030 x 800 mm/40.5" x 31.4" plates)	36 plates/hr at 2,400 dpi (1,030 x 800 mm/40.5" x 31.4" plates)	26 plates/hr at 2,400 dpi (1,030 x 800 mm/40.5" x 31.4" plates)
Interface	S-PIF			
Plate transport	Semi-automatic loading (standard), Fully-automatic loading (optional), Plate transport system (optional)			
Punch systems	Screen, Heidel, Heidelberg W, Protocol, Komori, and others			
Dimensions (W x D x H)	Main unit: 2,446 x 1,295 x 1,390 mm (96.3" x 51" x 54.8") Blower unit: 693 x 675 x 550 mm (27.3" x 26.6" x 21.7"); Chiller unit: 460 x 580 x 750 mm (18.2" x 22.9" x 29.6")			
Weight	Main unit: 1,150 kg (2530 lb); Blower unit: 85 kg (187 lb); Chiller unit: 79 kg (173.8 lb)			
Power requirements	Main unit: Single phase 200 V to 240 V, 21 A, 4 kW (Approved UL, CSA, Declared CE) Chiller unit: Single phase 200/208/220/230/240 V, 8 A, 1.4 kW (Approved UL, CSA, Declared CE) [SA-L, MA-L, AT-T, AT-M, and blower unit are supplied by main unit.]			
Environment	Recommended: 21 to 25°C (69.8 to 77°F); Required: 18 to 26°C (64.4 to 78.8°F); Relative humidity: 40 to 70% (no condensation)			
Options	SA-L8800N-ZX MA-L8800N-ZX	SA-L8800N, MA-L8800N High-resolution printing option (4,000 dpi)* ⁶ Notchless option* ⁶ , feed tray, plate transport system (built-in bridge, AT-T8001R, AT-M8001), various printing press punches, support for 0.4 mm thickness, optional registration punch (600)* ⁷ , signal tower unit		

*1. If the notchless option is not selected, the maximum exposure size is 1,160 x 926 mm (45.6" x 36.4"). The productivity of units with the notchless option is also different.

*2. The factory option thickness of 0.4 mm (15.7 mil) is only available for plates 1,030 x 770 mm (40.5" x 30.3") or larger. *3. 1,200 dpi uses 2,400 dpi double dots.

*4. Over four consecutive exposures on a single plate (temperature: 23°C; relative humidity: 60%). *5. Productivity may vary depending on the sensitivity of the media. *6. Option must be selected before the unit is shipped from the factory.

*7. Required for plates 590 mm (23.3") or wider, but less than 610 mm (24") wide.

PlateRite 8600N-Z/S/E specifications

	PlateRite 8600N-Z	PlateRite 8600N-S	PlateRite 8600N-E
Recording system	External drum		
Light source	64-channel laser diodes		32-channel laser diodes
Plate size	Maximum: 1,160 x 940 mm (45.6" x 37"); Minimum: 304 x 370 mm (12.0" x 14.6")		
Exposure size	Maximum: 1,160 x 924 mm (45.6" x 36.3")* ¹		
Media	Thermal plates		
Media thickness	0.15 to 0.3 mm (5.9 to 11.8 mil) [0.4 mm (15.7 mil) available as an option]		
Resolutions	1,200* ² /2,000* ² /2,400/2,438/2,540/4,000 dpi	1,200* ² /2,400/2,438/2,540 dpi	
Repeatability	± 5 microns* ³		
Productivity* ⁴	23 plates/hr at 2,400 dpi (1,030 x 800 mm/40.5" x 31.4" plates)		14 plates/hr at 2,400 dpi (1,030 x 800 mm/40.5" x 31.4" plates)
Interface	F-PIF		
Plate transport	Semi-automatic loading (standard), Fully-automatic loading (optional), Plate transport system (optional)		
Punch systems	Screen, Heidel, Heidelberg W, Protocol, Komori, and others		
Dimensions (W x D x H)	Main unit: 2,446 x 1,295 x 1,390 mm (96.3" x 51" x 54.8"); Blower unit: 693 x 675 x 550 mm (27.3" x 26.6" x 21.7")		
Weight	Main unit: 1,150 kg (2,530 lb); Blower unit: 85 kg (187 lb)		
Power requirements	Main unit: Single phase 220 V to 240 V, 32A, 4 kW (Approved UL, CSA, Declared CE) (SA-L, MA-L, AT-T, AT-M, and blower unit are supplied by main unit.)		
Environment	Recommended: 21 to 25°C (69.8 to 77°F); Required: 18 to 26°C (64.4 to 78.8°F); Relative humidity: 40 to 70% (no condensation)		
Options	SA-L8800N, MA-L8800N, feed tray, plate transport system (built-in bridge, AT-T8001R, AT-M8001), various printing press punches, support for 0.4 mm thickness, optional registration punch (600)* ⁵ , signal tower unit.		

*1. A 24-mm portion remains unexposed when 12-mm clamps are used. A 16-mm portion remains unexposed when 8-mm clamps are used. Productivity is different when 8-mm clamps are used.

*2. 1,200 dpi uses 2,400 dpi double dots. 2,000 dpi uses 4,000 dpi double dots. *3. Over four consecutive exposures on one plate at 23°C (73.4°F) and 60% relative humidity.

*4. Productivity may vary depending on the sensitivity of the media. *5. Required for plates 590 mm (23.3") or wider, but less than 610 mm (24") wide.

AT-M8001 plate transport system specifications

Dimensions (W x D x H)	2,150 x 1,655 x 955 mm (84.7" x 65.2" x 37.6")
Weight	180 kg (396 lb)
Power requirements	Supplied by main unit
Environment	Recommended: 21 to 25°C (69.8 to 77°F); Required: 18 to 26°C (64.4 to 78.8°F); Relative humidity: 40 to 70% (no condensation)
Options	Left-turn transport layout, straight-line transport bridge

PlateRite 8300N-S/E specifications

	PlateRite 8300N-S	PlateRite 8300N-E
Recording system	External drum	
Light source	32-channel laser diodes	16-channel laser diodes
Plate size	Maximum: 1,160 x 940 mm (45.6" x 37"); Minimum: 304 x 370 mm (12.0" x 14.6")	
Exposure size	Maximum: 1,160 x 924 mm (45.6" x 36.3") ^{*1}	
Media	Thermal plates	
Media thickness	0.15 to 0.3 mm (5.9 to 11.8 mil) [0.4 mm (15.7 mil) available as an option]	
Resolutions	1,200 ^{*2} /2,000/2,400/2,438/2,540/4,000 ^{*3} dpi	2,400/2,438/2,540 dpi (1,200 dpi ^{*2} output is also supported by upgraded PlateRite 8300 units.)
Repeatability	± 5 microns ^{*4}	
Productivity ^{*5}	14 plates/hr at 2,400 dpi (1,030 x 800 mm/40.5" x 31.4" plates)	8 plates/hr at 2,400 dpi (1,030 x 800 mm/40.5" x 31.4" plates)
Interface	F-PIF	
Plate transport	Semi-automatic loading (standard), Fully-automatic loading (optional), Plate transport system (optional)	
Punch systems (optional)	Screen, Heidel, Heidelbach W, Protocol, Komori, and others	
Dimensions (W x D x H)	Main unit: 2,446 x 1,295 x 1,390 mm (96.3" x 51.0" x 54.8") Blower unit: 693 x 675 x 550 mm (27.3" x 26.6" x 21.7")	
Weight	Main unit: 1,150 kg (2,530 lb); Blower unit: 85 kg (187 lb)	
Power requirements	Main unit: Single phase 220 V to 240 V, 32A, 4 kW (Approved UL, CSA, Declared CE) (SA-L, MA-L, AT-T, AT-M, and blower unit are supplied by main unit.)	
Environment	Recommended: 21 to 25°C (69.8 to 77°F); Required: 18 to 26°C (64.4 to 78.8°F); Relative humidity: 40 to 70% (no condensation)	
Options	SA-L8800N, MA-L8800N, feed tray, plate transport system (built-in bridge, AT-T8001R, AT-M8001) ^{*6} , various printing press punches, support for 0.4 mm thickness, optional registration punch (600) ^{*7} , signal tower unit.	

^{*1} A 24-mm portion remains unexposed when 12-mm clamps are used. A 16-mm portion remains unexposed when 8-mm clamps are used. Productivity is different when 8-mm clamps are used.

^{*2} 1,200 dpi uses 2,400 dpi double dots. ^{*3} When outputting at 4,000 dpi, confirm output quality before use. ^{*4} Over four consecutive exposures on one plate at 23°C (73.4°F) and 60% relative humidity.

^{*5} Productivity may vary depending on the sensitivity of the media. ^{*6} PlateRite 8300N-E (included upgraded model) requires the rear delivery kit.

^{*7} Required for plates 590 mm (23.3") or wider, but less than 610 mm (24") wide.

Autoloader specifications

	SA-L8800N-ZX	SA-L8800N	MA-L8800N-ZX	MA-L8800N
Compatible models	PlateRite 8800N-ZX	PlateRite 8800N-Z/S/E, PlateRite 8600N, PlateRite 8300N	PlateRite 8800N-ZX	PlateRite 8800N-Z/S/E, PlateRite 8600N, PlateRite 8300N
Plate transport	Fully automated (automatic interleaf paper removal)			
Cassette capacity	100 plates		100 plates per cassette	
No. of cassettes	—		Up to 5 cassettes (3 cassettes standard)	
Dimensions (W x D x H)	1,758 x 1,806 x 1,280 mm (69.3" x 71.2" x 50.4")		3,213 x 1,806 x 1,280 mm (126.5" x 71.2" x 50.4")	
Weight ^{*2}	600 kg (1,320 lb)		1,250 kg (2,750 lb)	
Power requirements	Supplied by main unit			
Environment	Recommended: 21 to 25°C (69.8 to 77°F); Required: 18 to 26°C (64.4 to 78.8°F); Relative humidity: 40 to 70% (no condensation)			
Standard accessories	1 carrier-type cassette, interleaf paper disposal box		Interleaf paper disposal box	
Options	Additional carrier-type cassettes (with dustproof covers), 304 mm small plate tray		Additional cassettes (with cassette trays and driver motors), 304 mm small plate tray	

^{*1} Cassette capacity may vary with plates that are 0.3 mm (11.8 mil) thick or thicker, or less than 450 mm (17.8") wide.

^{*2} Not including the weight of the plates. ^{*3} Required when using plates under 450 mm in width.

Dimensions

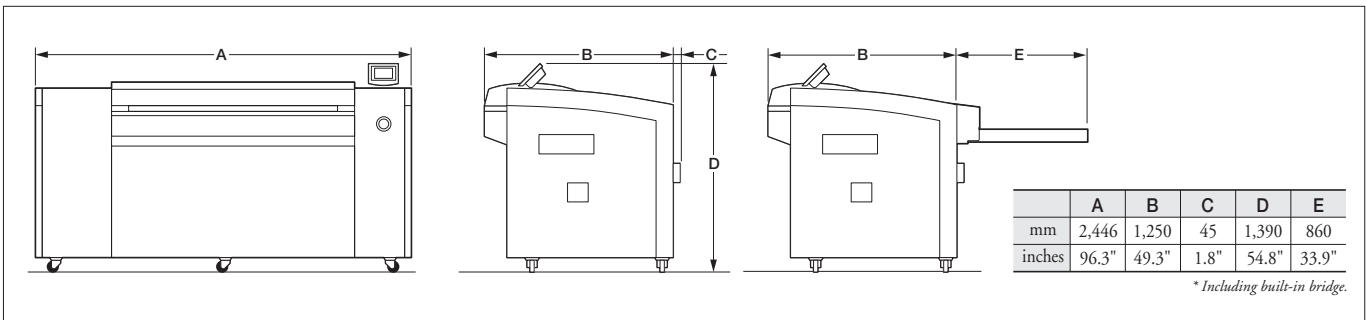

DAINIPPON SCREEN MFG. CO., LTD.

- *Grating Light Valve™ and GLV™ are trademarks of Silicon Light Machines.*
- *All other trademarks and registered trademarks used herein are the property of their respective owners.*

HEAD OFFICE

• Teranouchi-agaru 4-chome, Horikawa-dori, Kamigyo-ku, Kyoto, 602-8585 Japan/Phone +81-75-414-7610/Fax +81-75-414-7608

SCREEN (USA)

• 5110 Tollview Dr., Rolling Meadows, IL 60008, USA/Phone 847-870-7400/Fax 847-870-0149 www.screenusa.com

DAINIPPON SCREEN (DEUTSCHLAND) GmbH

• Mündelheimer Weg 39, 40472 Düsseldorf, Germany/Phone 0211-472701/Fax 0211-4727199

DAINIPPON SCREEN (U.K.) LTD.

• Michigan Drive, Tongwell, Milton Keynes, Buckinghamshire MK15 8HT, UK/Phone 01908-848500/Fax 01908-848501 www.screen.co.uk

DAINIPPON SCREEN (NEDERLAND) BV

• Bouwerij 46, 1185 XX Amstelveen, Holland/Phone 020-4567800/Fax 020-4567805 www.screen europe.com

DAINIPPON SCREEN SINGAPORE PTE. LTD.

• 29, Kaki Bukit View, Kaki Bukit Techpark II, Singapore 415963/Phone 67493833/Fax 67499010 www.screen sp.com.sg

DAINIPPON SCREEN (CHINA) LTD.

• Room 2001 - 2003, 20/F Cable TV Tower 9 Hoi Shing Road Tsuen Wan, N.T. Hong Kong/Phone +852-2953-0038/Fax +852-2755-8683

• Beijing office/Phone 010-6708-9271, 9272, 9273/Fax 010-6708-9395

• Shanghai office/Phone 021-3126-5122/Fax 021-5218-2199

• Guangzhou office/Phone 020-3891-1112/Fax 020-3891-1036

DAINIPPON SCREEN (TAIWAN) CO., LTD.

• 4F No. 126-1, Ming Tsu West Rd., Taipei, Taiwan/Phone 02-25862711/Fax 02-25914367

DAINIPPON SCREEN (KOREA) CO., LTD.

• 10th Yonsei Bongsnae B/D 48-3, 1Ga, Bongsnae-Dong, Joong-Gu, Seoul 100-161, Korea/Phone 02-7766-786/Fax 02-7766-787

DAINIPPON SCREEN (AUSTRALIA) PTY. LTD.

• Suite 11, 2 Eden, Park Drive, Macquarie, NSW2155, Australia/Phone +61-2-9016-3400/Fax +61-2-9016-3425

Internet web site : www.screen.co.jp

www.screenusa.com

www.screen europe.com

- This brochure was made using SPEKTA 2 screening.

We reserve the right to alter product design and specifications without prior notice.